

# BUSYPOD

Design Of Silence



Acoustic  
Office Furniture Solutions

# DISCOVER THE SILENCE & PRIVACY OF THE BUSINESS WORLD WITH BUSYPODS



As **BUSYPOD**, we work with original design and sustainable product development to offer ergonomic and modern sound-insulated work pods. We stand out with our creative approaches to provide efficient and quality work spaces to our customers.



# Product List

1



---

BUSYPOD  
Office Phone Booth

2



---

BUSYPOD  
Plus

3



---

BUSYPOD  
Medium Work

4



---

BUSYPOD  
Medium Meet

5



---

BUSYPOD  
Large 2-4

6



---

BUSYPOD  
XLarge

7



---

SLIMLINE  
One

8



---

SLIMLINE  
Plus

9



---

SLIMLINE  
Medium Work

10



---

SLIMLINE  
Large 2-4

11



---

SLIMLINE  
XLarge

12



---

BUSYLOUNGE  
2-4

13



---

BUSYMEET

# BUSYPOD OFFICE PHONE BOOTH

---



**BUSYPOD** is a phone booth designed to enhance focus by eliminating distracting noises. With its stylish design and specialized sound isolation, it brings quietness and productivity to your workspace. It stands out as a convenient solution for mobile work setups, boasting easy setup and durability. Suitable for any task requiring concentration, **BUSYPOD** is an ideal choice.



## Standard Exterior Side Panel



RAL 9005

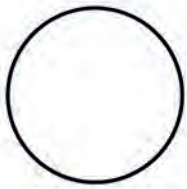

RAL 9016



RAL 7016



RAL 7042



RAL 1021



RAL 3002



RAL 6019



RAL 5012



OPTIONAL  
UNLIMITED COLORS

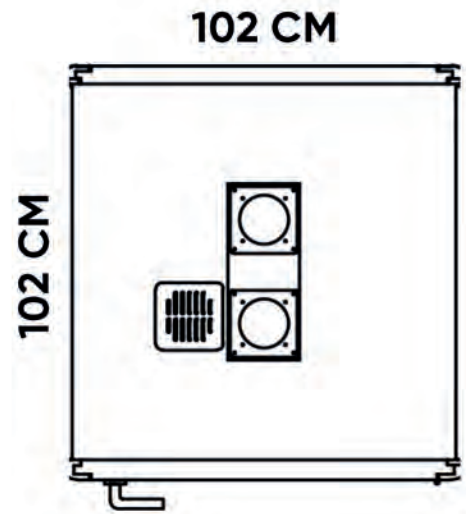

## Window / Door Frame & Table Materials



OAK



PINE



WALNUT

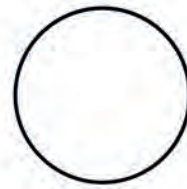

WHITE



BLACK



OPTIONAL  
UNLIMITED COLORS

### Options



1 PERSON



33,8 DB SOUND ISOLATION (ISO 23351-1 2020)



IT PROVIDES 180 TIMES OF AIR CIRCULATION PER HOUR



INSTALLATION IN 15 MINUTES WITH 2 PEOPLE



360 KG

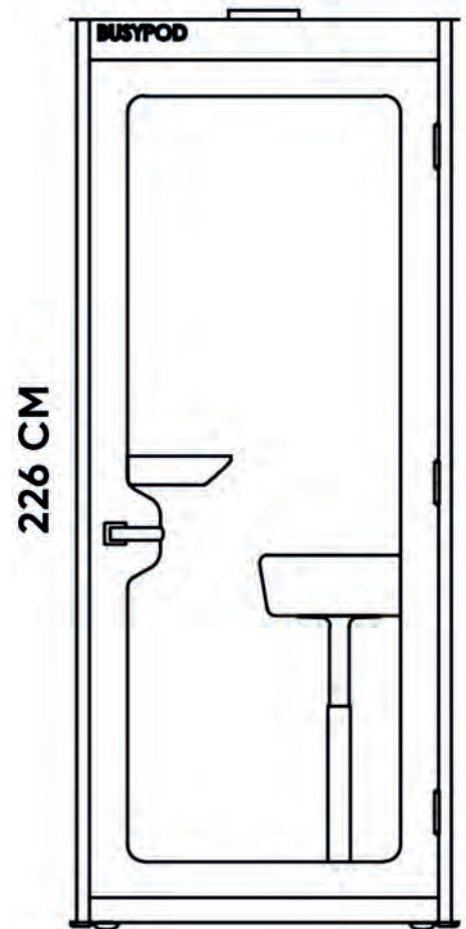

# BUSYPOD PLUS



**BUSYPOD Plus** is a office booth specially designed for work and meetings, equipped with a functional desk. While it blocks distracting noises with its special sound insulation, it offers a productive working environment thanks to the desk inside.



## Standard Exterior Side Panel



RAL 9005

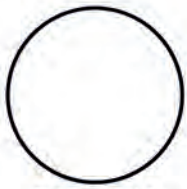

RAL 9016



RAL 7016



RAL 7042



RAL 1021



RAL 3002



RAL 6019



RAL 5012



OPTIONAL  
UNLIMITED COLORS

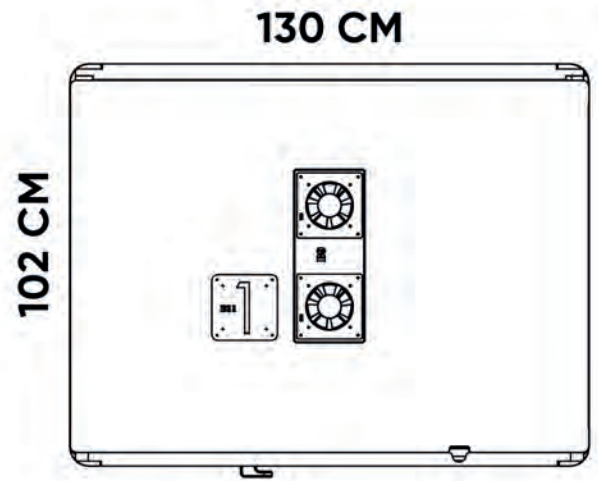

## Window / Door Frame & Table Materials



OAK



PINE



WALNUT

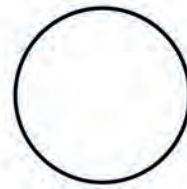

WHITE



BLACK



OPTIONAL  
UNLIMITED COLORS

### Options



33,8 DB SOUND ISOLATION (ISO 23351-1 2020)



IT PROVIDES 155 TIMES OF AIR CIRCULATION PER HOUR



INSTALLATION IN 25 MINUTES WITH 2 PEOPLE



460 KG

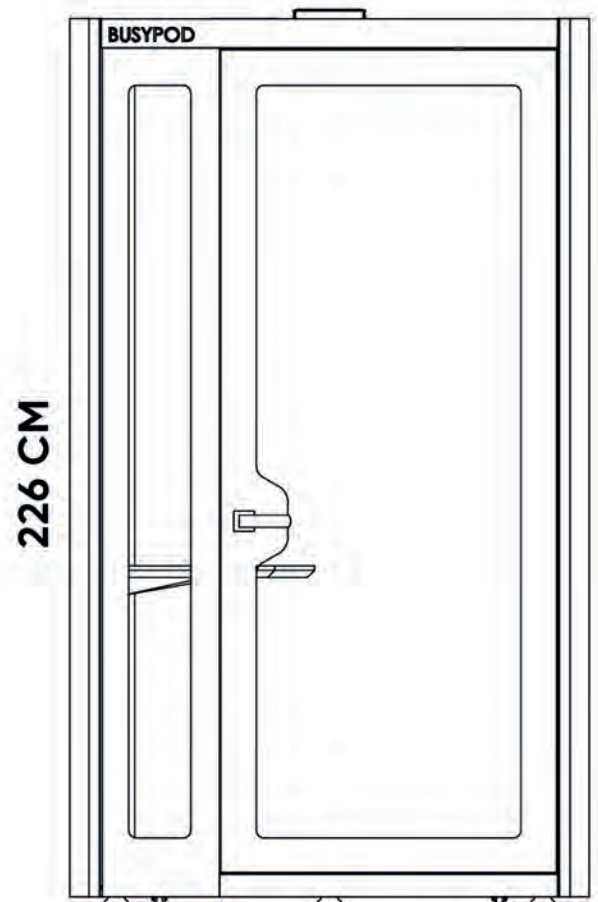

# BUSYPOD

## MEDIUM WORK



The sound-isolated **BUSYPOD** Medium Work is a solution designed to increase your focus and productivity. Ideal for your work and meetings, this product offers a quiet environment by keeping noise to a minimum. With its comfortable and ergonomic design, its size provides a comfortable working area and eliminates external factors that prevent you from focusing. **BUSYPOD Medium Work** offers a quiet and efficient working experience.



## Standard Exterior Side Panel



RAL 9005

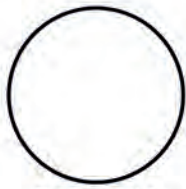

RAL 9016



RAL 7016



RAL 7042



RAL 1021



RAL 3002



RAL 6019



RAL 5012



OPTIONAL  
UNLIMITED COLORS

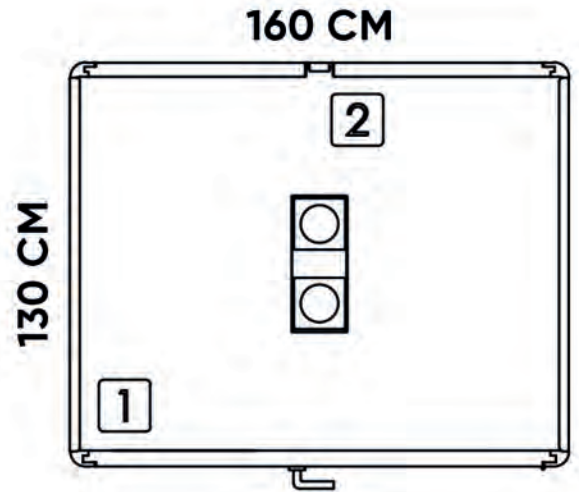

## Window / Door Frame & Table Materials



OAK



PINE



WALNUT

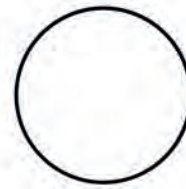

WHITE



BLACK



OPTIONAL  
UNLIMITED COLORS

### Options



1 PERSON



33,8 DB SOUND ISOLATION (ISO 23351-1 2020)



IT PROVIDES 100 TIMES OF AIR CIRCULATION PER HOUR



INSTALLATION IN 25 MINUTES WITH 2 PEOPLE



560 KG

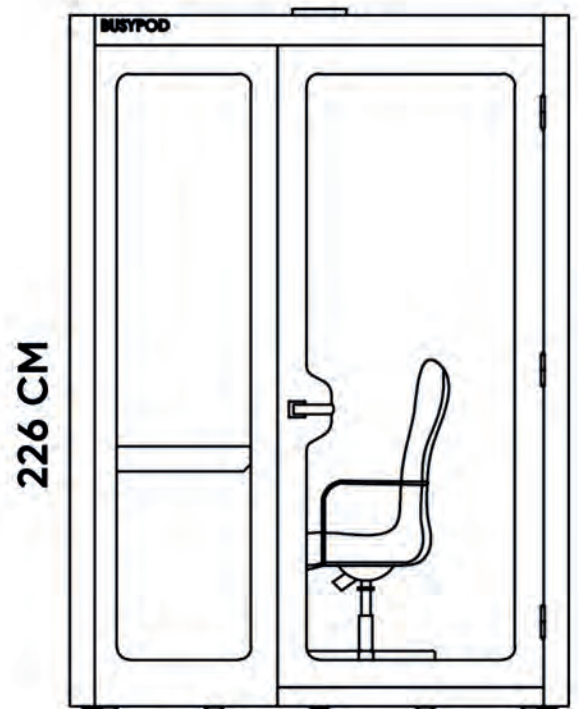

# BUSYPOD MEDIUM MEET

---



BUSYPOD Medium Meet is 2 people soundproof meeting cabin supports focus and efficient communication. It blocks external noises, ensures privacy, and offers an eye-catching design. It's ideal for business meetings and strategy sessions while providing a quiet and private space for effective communication.



## Standard Exterior Side Panel



RAL 9005

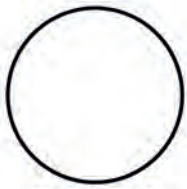

RAL 9016



RAL 7016



RAL 7042



RAL 1021



RAL 3002



RAL 6019



RAL 5012



OPTIONAL  
UNLIMITED COLORS

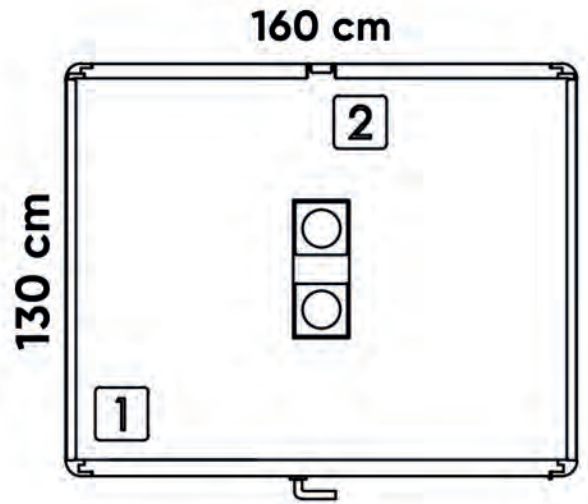

## Window / Door Frame & Table Materials



OAK



PINE



WALNUT

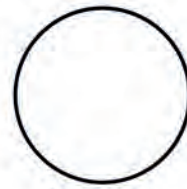

WHITE



BLACK



OPTIONAL  
UNLIMITED COLORS

### Options



2 PERSON



33,8 DB SOUND ISOLATION (ISO 23351-1 2020)



IT PROVIDES 100 TIMES OF AIR CIRCULATION PER HOUR



INSTALLATION IN 25 MINUTES WITH 2 PEOPLE



560 KG

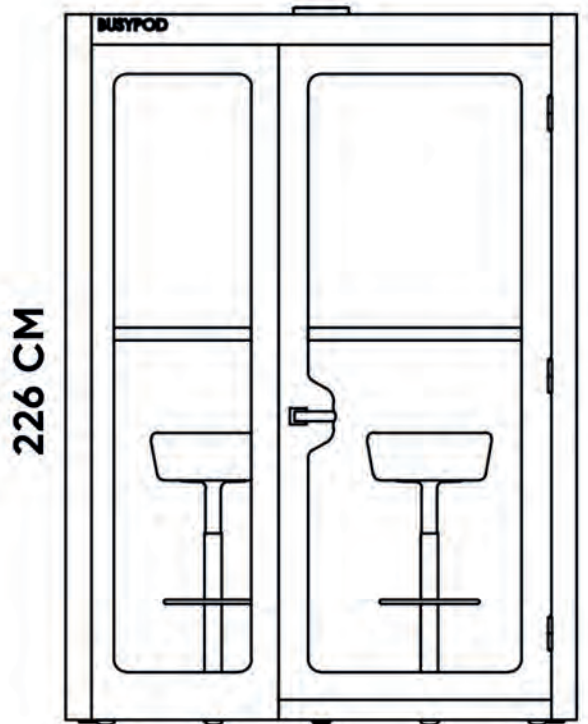

# BUSYPOD

## LARGE 2-4



BUSYPOD LARGEs are 2 and 4 people soundproof work and meeting cabins offer exclusive spaces that foster creativity and enhance productivity. While blocking external noise, they also add a modern touch to your office with their sleek designs. These cabins support focus and effective communication, catering to various uses from business meetings to team collaborations.



## Standard Exterior Side Panel



RAL 9005

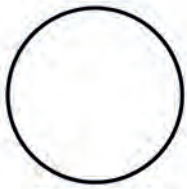

RAL 9016



RAL 7016



RAL 7042



RAL 1021



RAL 3002



RAL 6019



RAL 5012



OPTIONAL  
UNLIMITED COLORS

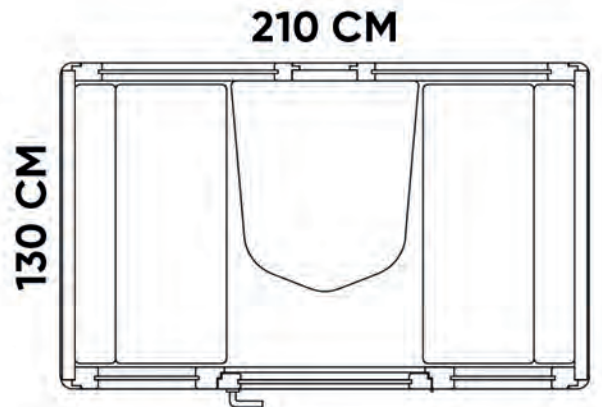
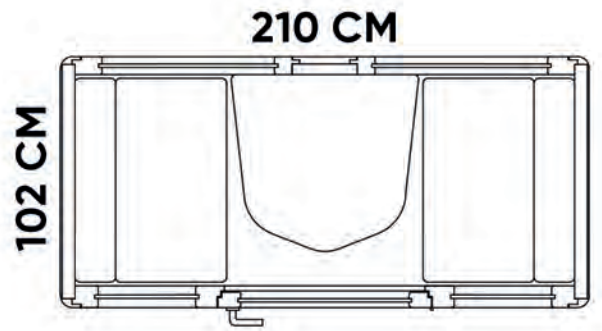

## Window / Door Frame & Table Materials



OAK



PINE



WALNUT

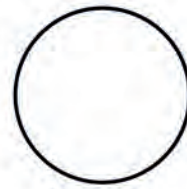

WHITE



BLACK



OPTIONAL  
UNLIMITED COLORS

### Options



2-4 PERSON



33,8 DB SOUND ISOLATION (ISO 23351-1 2020)



IT PROVIDES 128-140 TIMES OF AIR CIRCULATION PER HOUR



INSTALLATION IN 25 MINUTES WITH 2 PEOPLE



LARGE 2  
580 KG



LARGE 4  
680 KG

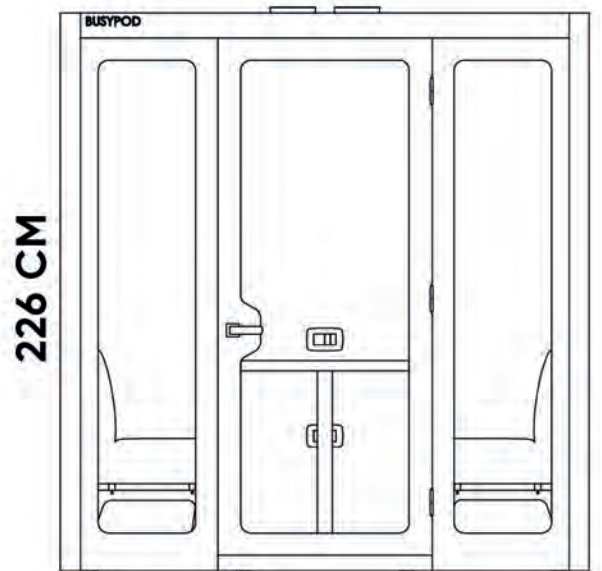

# BUSYPOD XLARGE



BUSYPOD XLarge is sound-insulated work and meeting cabin for 6-8 people. It's offer quick assembly with their demountable feature. While adding prestige to your workplace with its modern and stylish designs, it provides an ideal environment for productive meetings. It allows you to customize your workspaces with its flexible use.



## Standard Exterior Side Panel



RAL 9005

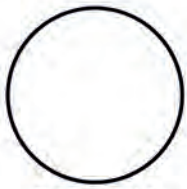

RAL 9016



RAL 7016



RAL 7042



RAL 1021



RAL 3002



RAL 6019



RAL 5012



OPTIONAL  
UNLIMITED COLORS

## Window / Door Frame & Table Materials



OAK



PINE



WALNUT

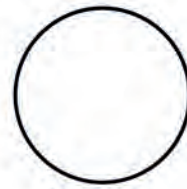

WHITE



BLACK



OPTIONAL  
UNLIMITED COLORS

### Options



6-8 PERSON



33,8 DB SOUND ISOLATION (ISO 23351-1 2020)



IT PROVIDES 110 TIMES OF AIR CIRCULATION PER HOUR



INSTALLATION IN 30 MINUTES WITH 4 PEOPLE



1430 KG

262 CM

280 CM

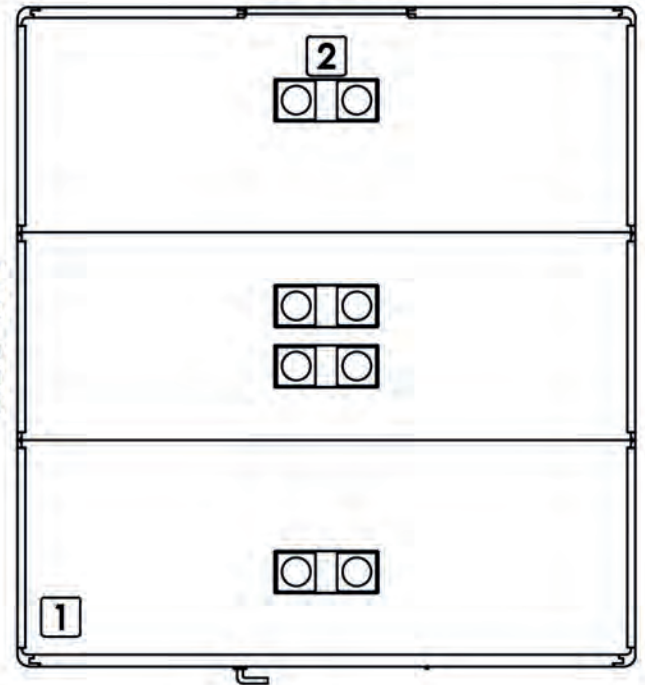

226 CM

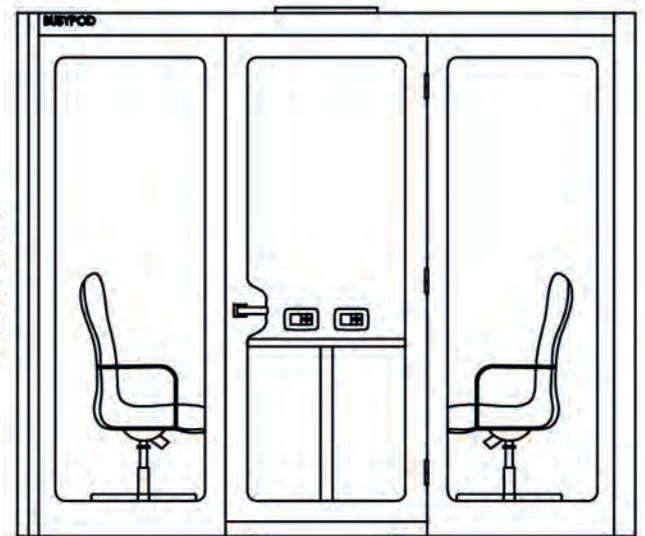

# BUSYPOD

## SLIMLINE ONE



**Slimline One** is a single-person acoustic cabin that attracts attention with its aesthetic appearance and effective sound insulation. With its elegant and delicately designed lines, it provides maximum performance with minimum space usage in your office or work environment.



## Standard Exterior Side Panel



RAL 9005

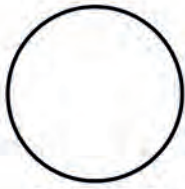

RAL 9016



RAL 7016



RAL 7042



RAL 1021



RAL 3002



RAL 6019



RAL 5012



OPTIONAL  
UNLIMITED COLORS

102 CM

102 CM

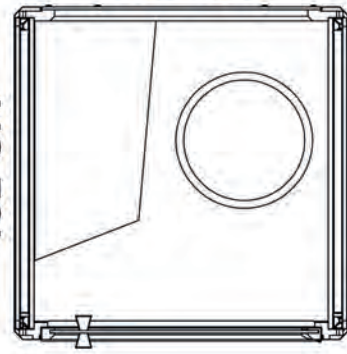

## Window / Door Frame & Table Materials



ASHWOOD



WALNUT

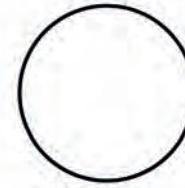

WHITE



BLACK

226 CM

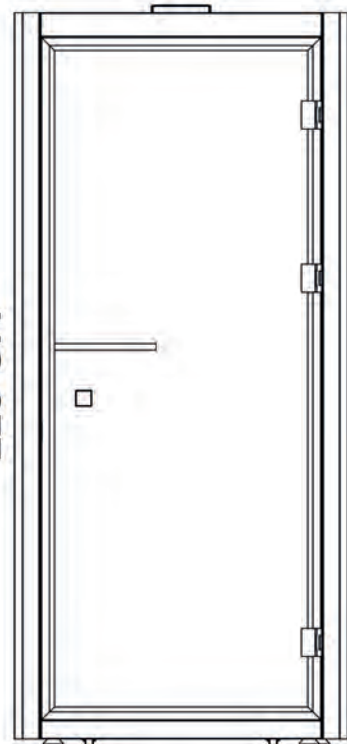

## Window / Door Frame & Table Materials



CLW 01  
STANDARD



CLW 07



CLW 15

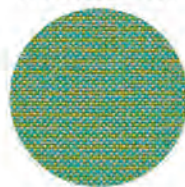

CLW 19



CLW 22

## Options



1 PERSON



28,5 DB SOUND ISOLATION (ISO 23351-1 2020)



IT PROVIDES 180 TIMES OF AIR CIRCULATION PER HOUR



INSTALLATION IN 15 MINUTES WITH 2 PEOPLE



325 KG

# BUSYPOD SLIMLINE PLUS

---



**Slimline Plus** effectively blocks outside sounds while increasing the concentration of the individual inside. It is ideal for one-person work or meetings and maximizes work efficiency.



## Standard Exterior Side Panel



RAL 9005



RAL 9016



RAL 7016



RAL 7042



RAL 1021



RAL 3002



RAL 6019



RAL 5012



OPTIONAL  
UNLIMITED COLORS

130 CM

102 CM

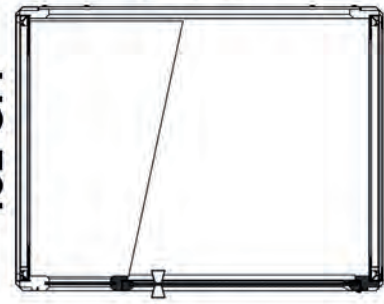

## Window / Door Frame & Table Materials



ASHWOOD



WALNUT

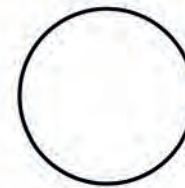

WHITE



BLACK

226 CM

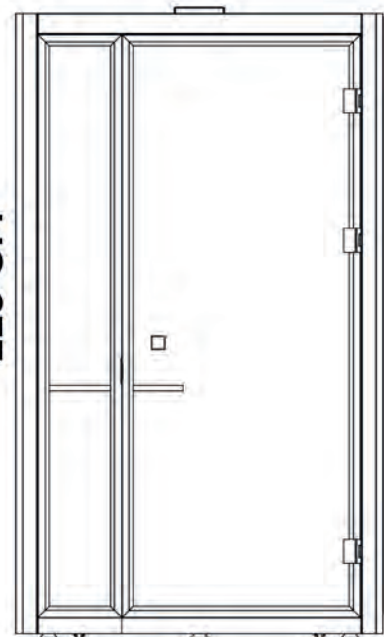

## Window / Door Frame & Table Materials



CLW 01  
STANDARD



CLW 07



CLW 15

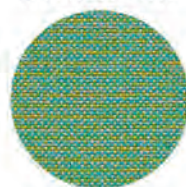

CLW 19



CLW 22

## Options



1 PERSON



28,5 DB SOUND ISOLATION (ISO 23351-1 2020)



IT PROVIDES 155 TIMES OF AIR CIRCULATION PER HOUR



INSTALLATION IN 25 MINUTES WITH 2 PEOPLE



410 KG

# BUSYPOD

## SLIMLINE MEDIUM WORK



**Slimline Medium Work** is a thoughtfully designed sound-insulated acoustic cabin solution used as a single-person work and meeting cabin. It provides an aesthetic contribution to modern working environments with its slim lines and stylish structure while providing a spacious area to the user.



## Standard Exterior Side Panel



RAL 9005

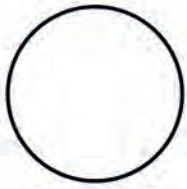

RAL 9016



RAL 7016



RAL 7042



RAL 1021



RAL 3002



RAL 6019



RAL 5012



OPTIONAL  
UNLIMITED COLORS

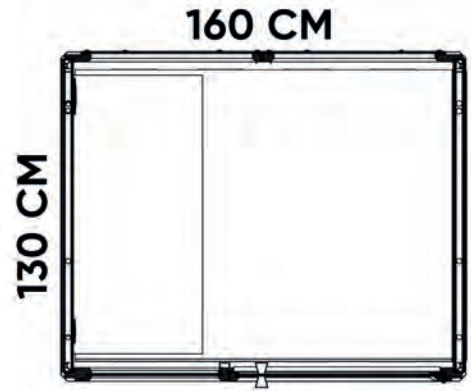

## Window / Door Frame & Table Materials



ASHWOOD



WALNUT

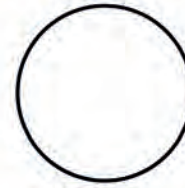

WHITE



BLACK

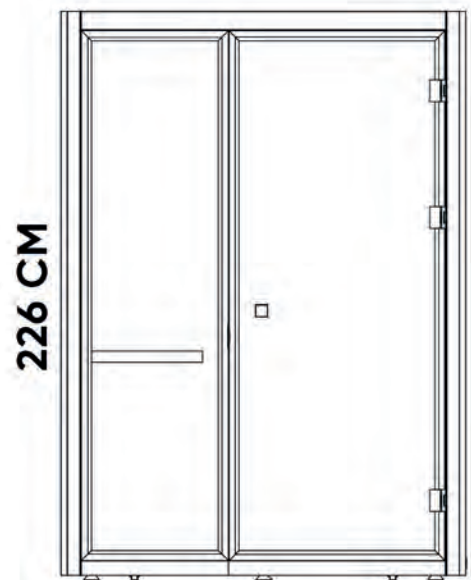

## Window / Door Frame & Table Materials



CLW 01  
STANDARD



CLW 07



CLW 15

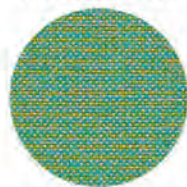

CLW 19



CLW 22

## Options



1 PERSON



28,5 DB SOUND ISOLATION (ISO 23351-1 2020)



IT PROVIDES 155 TIMES OF AIR CIRCULATION PER HOUR



INSTALLATION IN 25 MINUTES WITH 2 PEOPLE



410 KG

# BUSYPOD

## SLIMLINE LARGE 2-4



Our 2 and 4-people model, specially designed for your workplace, allow you to focus with excellent sound insulation. It is ideal for productive meetings with its flexible use and modern style. If you are looking for silence and efficiency together, discover our cabins!



## Standard Exterior Side Panel



RAL 9005

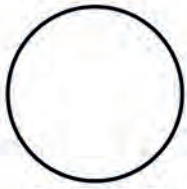

RAL 9016



RAL 7016



RAL 7042



RAL 1021



RAL 3002



RAL 6019



RAL 5012



OPTIONAL  
UNLIMITED COLORS

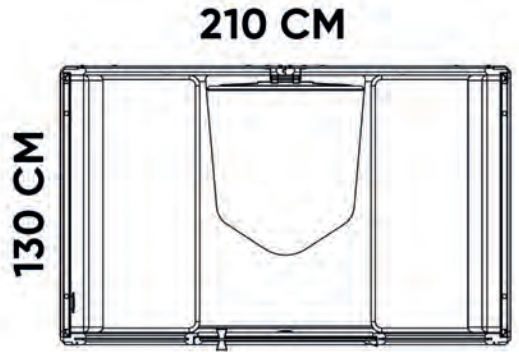
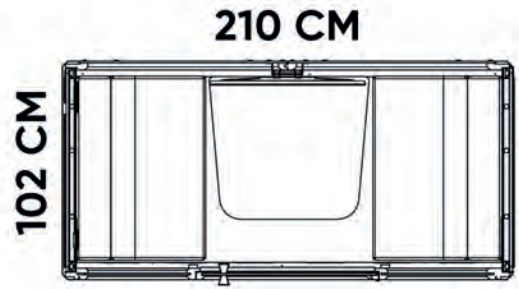

## Window / Door Frame & Table Materials



ASHWOOD



WALNUT

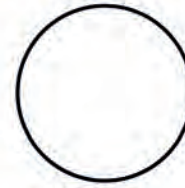

WHITE



BLACK

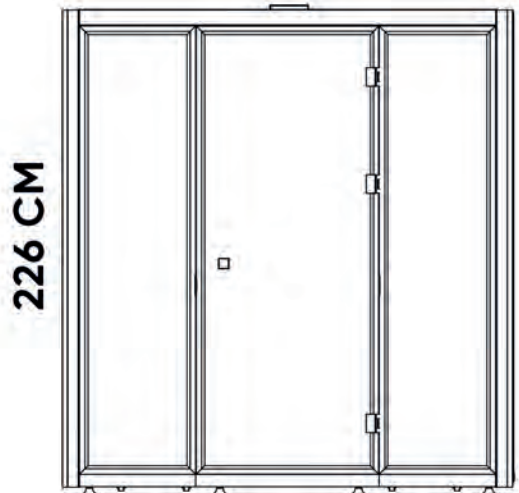

## Window / Door Frame & Table Materials



CLW 01  
STANDARD



CLW 07



CLW 15

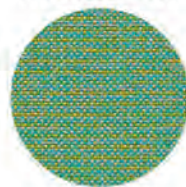

CLW 19



CLW 22

## Options



2-4 PEOPLE



28,5 DB SOUND ISOLATION (ISO 23351-1 2020)



IT PROVIDES 110 TIMES OF AIR CIRCULATION PER HOUR



INSTALLATION IN 30 MINUTES WITH 4 PEOPLE



LARGE 2  
530 KG



LARGE 4  
600 KG

# BUSYPOD SLIMLINE XLARGE

---



**Slimline XLarge** is an acoustic meeting cabin for 6-8 people that stands out with its large capacity, sound insulation and aesthetic design. The product is shipped disassembled and can be easily assembled by only 3-4 people.



## Standard Exterior Side Panel



RAL 9005



RAL 9016



RAL 7016



RAL 7042



RAL 1021



RAL 3002



RAL 6019



RAL 5012



OPTIONAL  
UNLIMITED COLORS

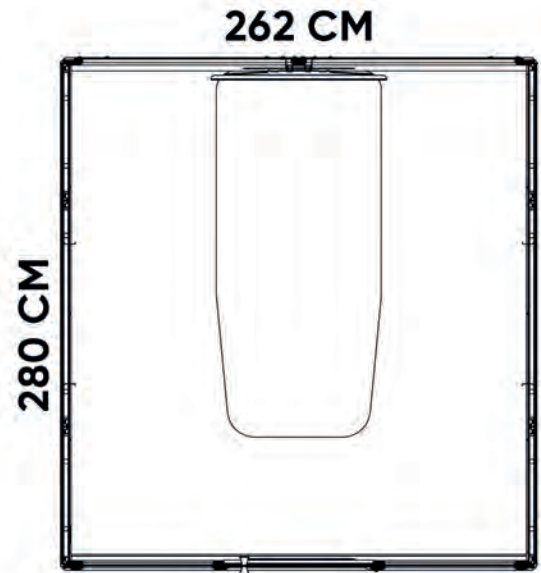

## Window / Door Frame & Table Materials



ASHWOOD



WALNUT

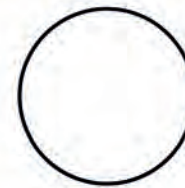

WHITE



BLACK

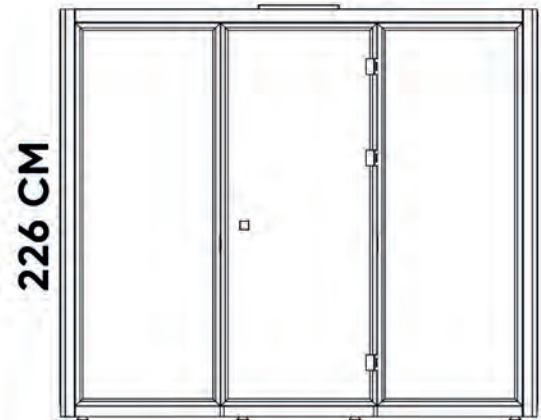

## Window / Door Frame & Table Materials



CLW 01  
STANDARD



CLW 07



CLW 15

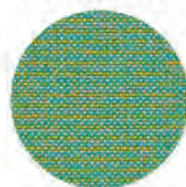

CLW 19



CLW 22

## Options



6-8 PEOPLE



28,5 DB SOUND ISOLATION (ISO 23351-1 2020)



IT PROVIDES 110 TIMES OF AIR CIRCULATION PER HOUR



INSTALLATION IN 30 MINUTES WITH 4 PEOPLE



1200 KG

# BUSYLOUNGE



**BUSYLOUNGE** offers portable and demountable seating and meeting cabins for 2 and 4 individuals designed for office usage. It focuses on balancing sound and adds a touch of modern design to office spaces. With its wheeled structure, it's easily transportable and adaptable to various spaces. Its versatile use creates an efficient environment for meetings or relaxation.



### Standard Exterior Side Panel



RAL 7016

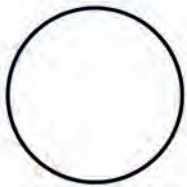

RAL 9016

### Window / Door Frame & Table Materials



OAK



HUS

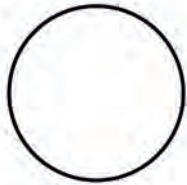

RAL 9016



RAL 7016

### LIGHTING FELT COLOR



FLT 01



FLT 02



2-4 PEOPLE



INSTALLATION IN 25 MINUTES WITH 2 PEOPLE



BUSYLOUNGE 2  
380 KG



BUSYLOUNGE 4  
560 KG

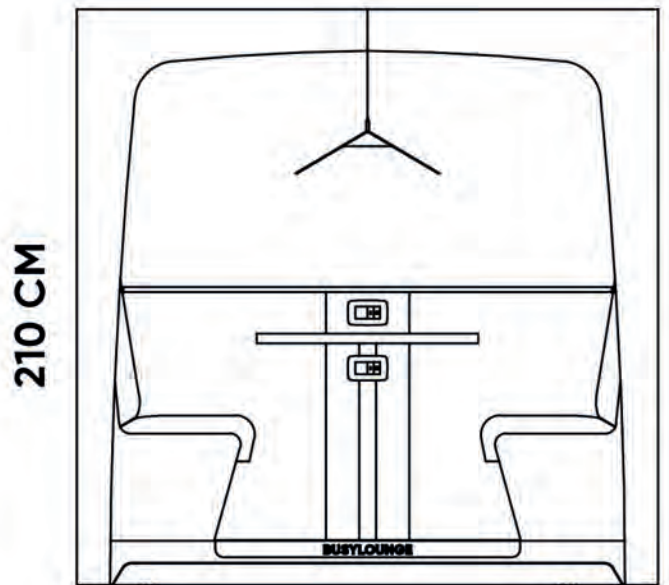
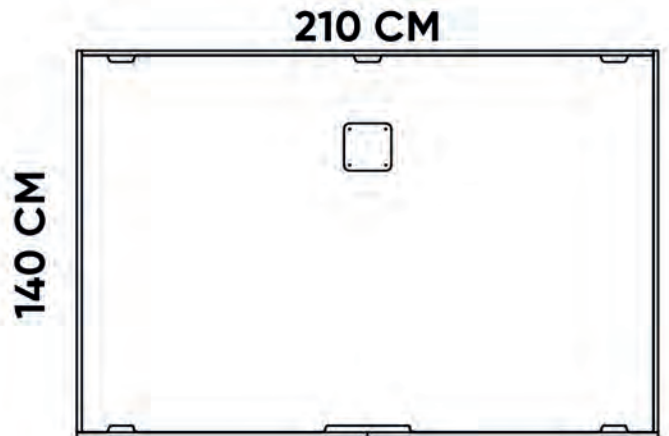
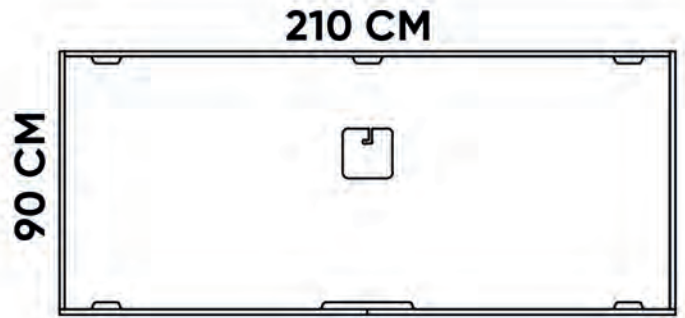

# BUSYMEET

---



**BUSYMEET** is an exciting product designed to increase the dynamism of offices in terms of collaboration and productivity. With its seating arrangement for 4 people, it facilitates interaction between teams and meetings with customers.



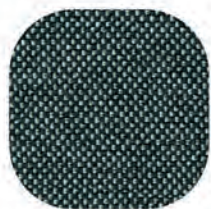

EGL 37



EGL 50



EGL 26



EGL 15



EGL 01

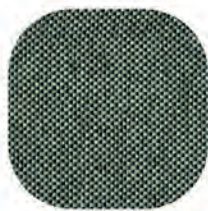

EGL 34

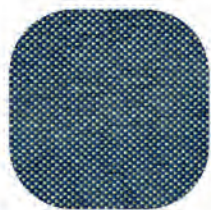

EGL 27

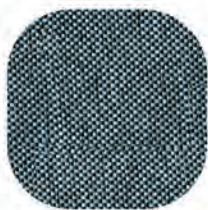

EGL 48



EGL 35



EGL 13



EGL 09



EGL 12

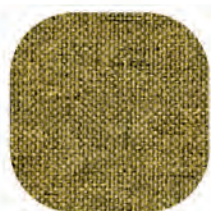

EGL 10



EGL 14

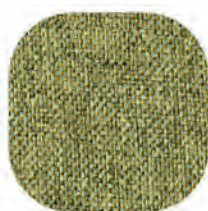

EGL 07



EGL 19

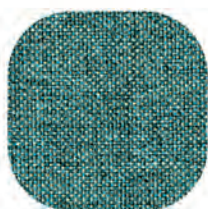

EGL 21

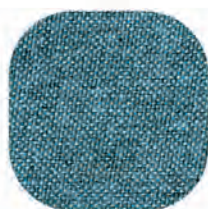

EGL 23

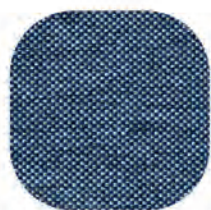

EGL 24

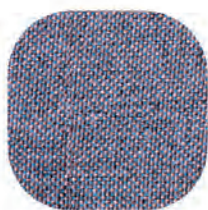

EGL 08



EGL 33

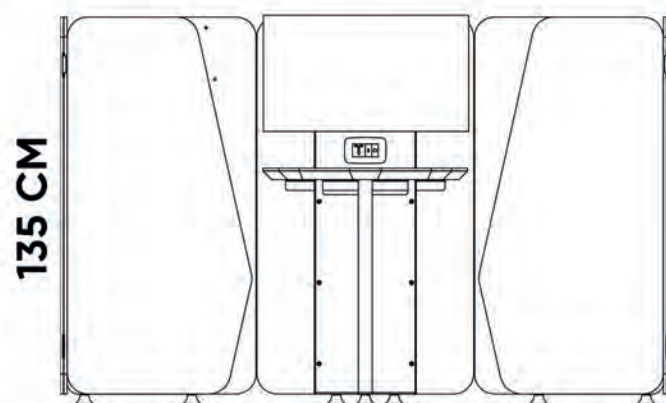
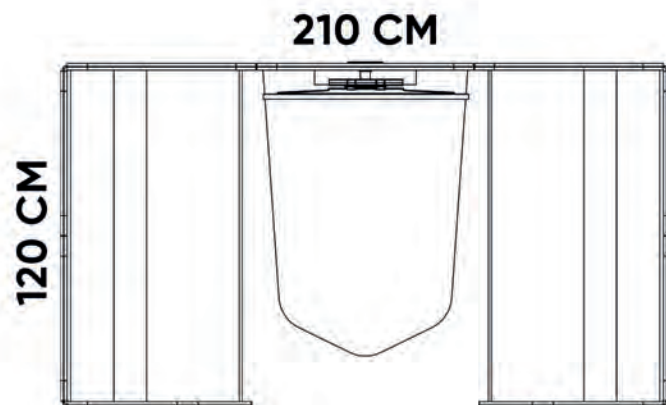

4 PEOPLE



INSTALLATION IN 25 MINUTES WITH 2 PEOPLE



BUSYMEET  
220 KG



## Standard Felt Metaterials



Standard Grey

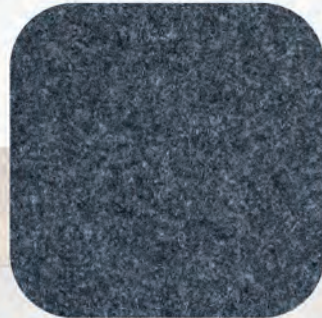

Standard Dark Grey

## Optional Felt Metaterials



Green

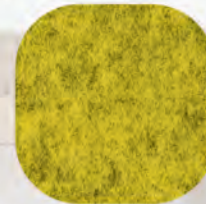

Yellow



Blue



FLM 03



FLM 04



FLM 09



FLM 15



FLM 19



FLM 20



FLM 22



FLM 23



FLM 24



FLM 26



FLM 31



FLM 32

## Upholstery Metaterials



EGL 37



EGL 50



EGL 26

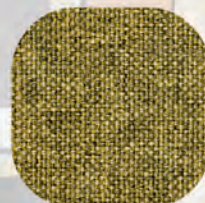

EGL 10



EGL 14

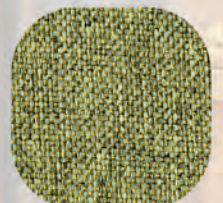

EGL 07

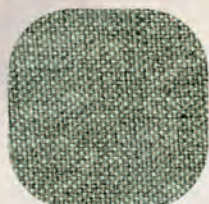

EGL 15

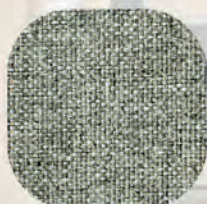

EGL 01

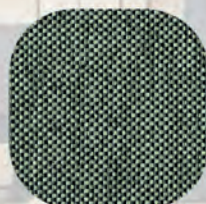

EGL 34



EGL 19

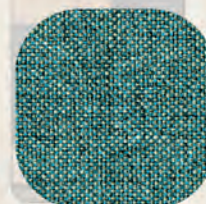

EGL 21

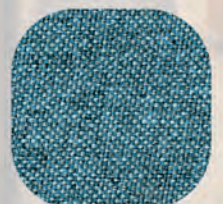

EGL 23

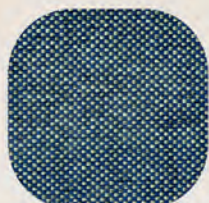

EGL 27

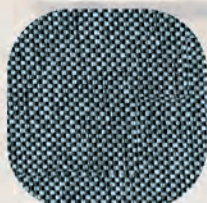

EGL 48

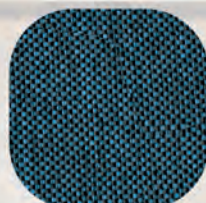

EGL 35

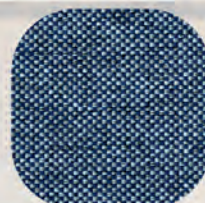

EGL 24

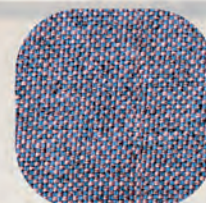

EGL 08



EGL 33



EGL 13

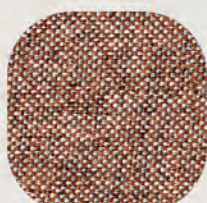

EGL 09

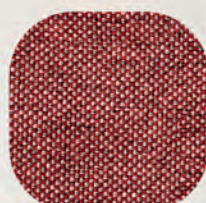

EGL 12

**Camira-Rivet** is our standard fabric option (Before decision, please ask availability in stock for quicker delivery). We have many other fabric options (which may apply extra costs). You can click on the name of the fabrics to see.

**Camira-Rivet, Camira-Era, Camira-Synergy,**





Silent ventilation fans make less noise than traditional fans, keeping their silence in **BUSYPOD** products. In this way, you can enjoy the silence while meeting your ventilation needs.



Ethernet lines offer a reliable and flexible network connection. It both offers a more stable connection than wireless networks and allows you to seamlessly connect multiple devices on the same network.



Optional wireless phone chargers have aesthetic designs that are compatible with booths. In this way, chargers can be integrated without to ruin the appearance of the booth. Stylish and minimalist designs enhance the user experience while also contributing to the aesthetics of the space.



Disabled ramps provide seamless access to BUSYPODs in the office for individuals who use wheelchairs or have walking difficulties. Thanks to these ramps, disabled individuals can walk around the office in accordance with their own needs and easily reach the BUSYPODs. This forms an important part of an inclusive work environment.



Optional monitors enable presentations, data sharing and the ability to communicate ideas more effectively in meeting rooms. Attendees better understand the visuals presented on a large, clear screen and increase the impact of presentations. At the same time, more interaction and participation is added to meetings with interactive monitors.



Motion sensors make BUSYPODs in the office more user-friendly. When you enter the booth, the lighting system is activated automatically. In addition, the lights turn off automatically when the booth is empty or inactive for a certain period of time. This contributes to sustainability goals by saving energy.



Manual locks, only available in **BUSYPOD Premium Series**, give users the freedom to feel to secure and protect their privacy. Locks inside securely the booth during phone calls, meetings or gatherings. Individual study prevents outside intervention. This feature gives users complete control over it.



Fire sensors offer the opportunity for early fire detection. Fire sensors used in BUSYPOD Booths quickly and precisely detect fire hazards. In this way, quick action is taken in case of fire and possible damages are minimized.

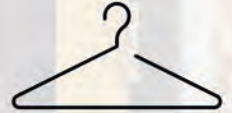

Coat hangers allow you to hang your clothes neatly before meetings or important interviews. This helps you create a professional and organized look.



Optional wheels eliminate the need to use BUSYPOD Booths in a fixed location. You can move Booths to different areas as needed. Thus, you can create more flexible workspaces by quickly changing the layout in your workplace.



# BUSYPOD

## Design Of Silence

### GET IN TOUCH

#### CONTACT US



+90 216 771 96 69



[www.busypod.com](http://www.busypod.com)



[info@busypod.com](mailto:info@busypod.com)



Ataşehir Ferhatpaşa Mahallesi Mareşal Çakmak Caddesi 23. Sokak No:16 34888  
Ataşehir / İstanbul / TÜRKİYE



Follow us on social media